



WORK STATION SOLUTIONS

OUR CONNECTIVITY SOLUTIONS PROVIDE LEADING-EDGE PERFORMANCE TECHNOLOGY PLUS A MIGRATION PATH TO SUPPORT EMERGING APPLICATIONS. MAXIMIZING YOUR NETWORK PERFORMANCE AND RETURN-ON-INVESTMENT WELL INTO THE FUTURE.



FACE PLATE ASSEMBLIES • OUTLET FRAMES • SURFACE BOXES • JACKS • CATEGORY 6 SYSTEM ADAPTERS • FRONT-LOADING FACE PLATES • FURNITURE PLATES • SHIELDED JACKS • SPEAKER ADAPTERS • SURFACE MOUNT BOXES • NEXTSPEED PRODUCTS • MULTIMEDIA CONNECTION SYSTEM CHANNEL • MODULAR PLUGS • CROSS CONNECT SYSTEMS • PATCH PANELS • RACK MOUNT KITS • MULTIMEDIA PANELS • CONSOLIDATION POINTS • PHONE PLATES • OUTLET PLATES • REAR-LOADING FACE PLATES • BULK CONNECTIONS • CATEGORY 3 • TAMPER-RESISTANT FACE PLATES • I-ISTATION AUDIO VIDEO MODULES

WORK STATION CONTENTS



PRODUCT	PAGE
MODULAR JACKS.....	B4
SHIELDED JACKS.....	B6
JACK ACCESSORIES.....	B7
AUDIO VIDEO CONNECTORS.....	B8
KEYSTONE ADAPTERS.....	B12
I-ISTATION™ MODULAR AV SYSTEM.....	B14
HDMI CONNECTORS AND PATCH CORDS.....	B19
PLUG-N-PLAY X-END™ AV SYSTEM.....	B20
FRAMES AND BEZELS.....	B22
BLANK MODULES.....	B23
RECESSED WALL BOXES.....	B24
FURNITURE CONNECTIVITY BOXES.....	B26
FACE PLATES, REAR-LOADING.....	B28
DECORATOR PLATES AND FRAMES.....	B30
SPECIALTY PLATES.....	B31
TAMPER-RESISTANT AND FURNITURE PLATES.....	B32
INTERNATIONAL PLATES.....	B33
SURFACE MOUNT BOXES.....	B34
MULTIMEDIA HOUSINGS.....	B35
MODULAR ADAPTERS.....	B36

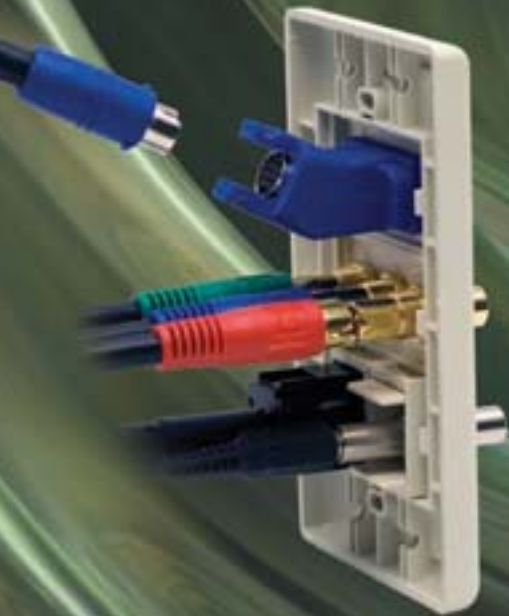



Ascent Category 6A Jacks

Design

- Enhanced common mode design eliminates residual and reflected NEXT and ANEXT.

Performance

- Balanced PCB design delivers significant headroom over the TIA Category 6A standard up to 500MHz providing true 10GbE application assurance.

Termination

- Wide IDC spacing allows for the easiest UTP lacing Category 6A jack in the industry.

Reliability

- Application: Third-Party qualified for 10 Gigabit Ethernet Transmission IEEE 802.3an.
- Component: Third-Party verified for TIA-568-C.2 Category 6A component.
- Channel: Third-Party tested for ISO 11801 Class EA compliant.
- Current Capacity: Qualified for PoE and PoE+ IEEE 802.3at.
- Mechanical: Third-Party verified to TIA-568-C.2.
- Manufacturing: 100% factory tested.

Specifications

- Nose contact material: Beryllium Copper with Precious Metal plating with Nickel under-plating.
- Contact performance confirmed over the full range of TIA plug deflection limits.

Standards

- ANSI/TIA-568-C.2 (Previously 568-B.2-10 Category 6A) component.
- ISO 11801 Class EA Compliant (Category 6A).
- IEEE 802.3at.
- UL Listed 1863.



Flexibility

- 15 different colors aids identification of multiple applications.

Superior Strain Relief

- Locking IDC stuffer cap ensures termination retention, securing wires during installation.

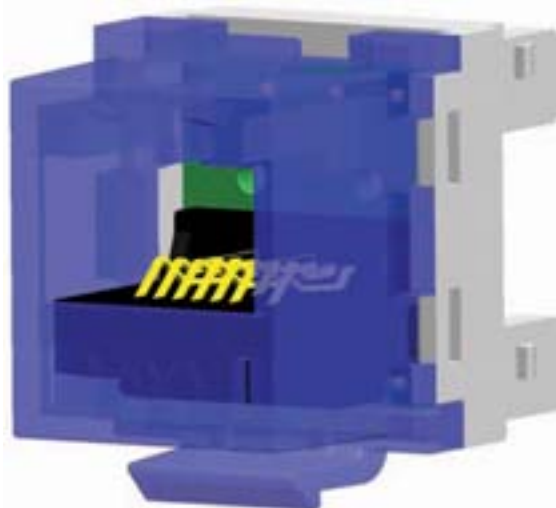

Capacity

- Small form factor allows up to 6 keystone connections in a single gang delivering maximum capacity within standard product.

Versatility

- NEXTSPEED® Ascent Jack fits in all Hubbell iSTATION™, Delivery and Cross Connect products.



- TIA and ISO Category 6A Component Compliance.
- Labor Savings: Exclusive 1-Punch Termination Reduces Termination Time by 75%.
- Mating Cycles Exceed Industry Standard by 2 Times.
- Bulk Packaged to Eliminate Excess Packing Waste.

NEXTSPEED® Ascent Category 6A Jacks



The NEXTSPEED® Ascent Category 6A jack exceeds TIA and ISO Category 6A component specifications supporting network protocols delivering maximum 10GbE bandwidth and extended reliability for all LAN, multimedia and Power over Ethernet applications.

Delivery: 1 per Bag/ Carton of 25.

25 per Bag/ Carton of 1

Catalog No. **HJ6AXX** ✓10G

Catalog No. **HJ6AXX25** ✓10G

XX = See Jack Color Options below.

XX = Jack Color Options

AL=Almond	BK=Black	B=Blue	EI=Electric Ivory	GL=Gold	GY=Gray	GN=Green	LA=Light Almond
OW=Office White	OR=Orange	P=Purple	R=Red	TI=Telco Ivory	W=White	Y=Yellow	



Features/Benefits

- PoE tested and verified.
- Universal Hubbell keystone design fits into all Hubbell iSTATION™ and Delivery Plus™ products.
- Exclusive 1-Punch termination tool and QuickLace™ combination.
- 15 different colors aids identification of multiple applications.

Specifications

- Construction Material:
 - Housing: High impact Thermoplastic (UL 94V-0).
 - Stuffer cap: Lexan (UL 94V-0).
 - Dust cover: Polypropylene.
- Nose contacts:
 - Material: Beryllium Copper with Precious Metal plating with Nickel under-plating.
- IDC contacts: Phosphor Bronze with 100 micro-inch Tin plating over Nickel under-plating.

Termination Towers

- Easy pair splitting.
- Simple lacing.
- Fast punch-down.



Stuffer Cap

- Secure strain relief.
- Positive "snap" latching.

Universal Wiring

- Two distinct labels eliminates wiring confusion, T568B or T568A.

HUBBELL Advantage

- Industry's First Tested Category 6 Component Compliant Jack.
- Labor Savings: Exclusive 1-Punch Termination Reduces Termination Time by 75%.
- Mating Cycles Exceed Industry Standards by 2 Times.
- Bulk Packaged to Eliminate Excess Packing Waste.

XCELERATOR™ Jacks, NEXTSPEED® and SPEEDGAIN® Category 6, 5e, 3 and USOC



See Jack Color Options Below

	Category 6	Category 5e	Category 3	RJ-25 (USOC)*	Color	RJ-61 (USOC)
Quantity = 1	HXJ6XX	HXJ5EXX	HXJ3XX	HXJUXX	Black	HXJU8BK25
Quantity = 25	HXJ6XX25	HXJ5EXX25	HXJ3XX25	-	Office White	HXJU8OW25

XX = See Jack Color Options below.

* Color exceptions: "P"=Purple and "GL"=Gold.

XX = Jack Color Options

AL=Almond	BK=Black	B=Blue	EI=Electric Ivory	GL=Gold	GY=Gray	GN=Green	LA=Light Almond
OW=Office White	OR=Orange	P=Purple	R=Red	TI=Telco Ivory	W=White	Y=Yellow	

HUBBELL NextSpeed

Superior Strain Relief

- Locking IDC stuffer cap ensures termination retention, securing wires during installation.

Performance

- 10GbE channel tested delivering 3Db of headroom @ 417MHz providing true 10GbE application assurance.

Reliability

- Application: Qualified for 10 Gigabit Ethernet Transmission IEEE 802.3an.
- Component: Third-Party verified for TIA-568-C Category 6 component - Third-Party verified for ISO 11801, Class E compliant.
- Current Capacity: Qualified for PoE and PoE+ IEEE 802.3at.
- Manufacturing: 100% factory tested.

Features/Benefits

- Zero Bit-Error channel performance.
- Controlled crosstalk.
- Quick and easy grounding.
- Backward compatible to Category 5e, 5.
- Hubbell keystone.
- Compatible with all iSTATION™ plates and modules.

Specifications

- ◆ Copper conductor diameter:
 - Solid: 0.40-0.65 mm/AWG 26/1-22/1
 - Stranded: 0.46-0.61 mm/AWG 27/7-24/7.
- ◆ Life (insertions): min. 750 cycles.
- ◆ Shielding housing: Zinc die-cast.

Standards

- ANSI/TIA-568-C.2 Category 6 component.
- UL Listed ISO/IEC 11801 and EN50173 2nd edition requirements for transfer impedance and shield effectiveness.
- IEC 60603-7-5 (draft) specifications for Category 6 and Category 5e screened connecting hardware.
- UL Listed 1863.

Shielded Jacks

Termination Technique

- User-friendly - requires no special tools.

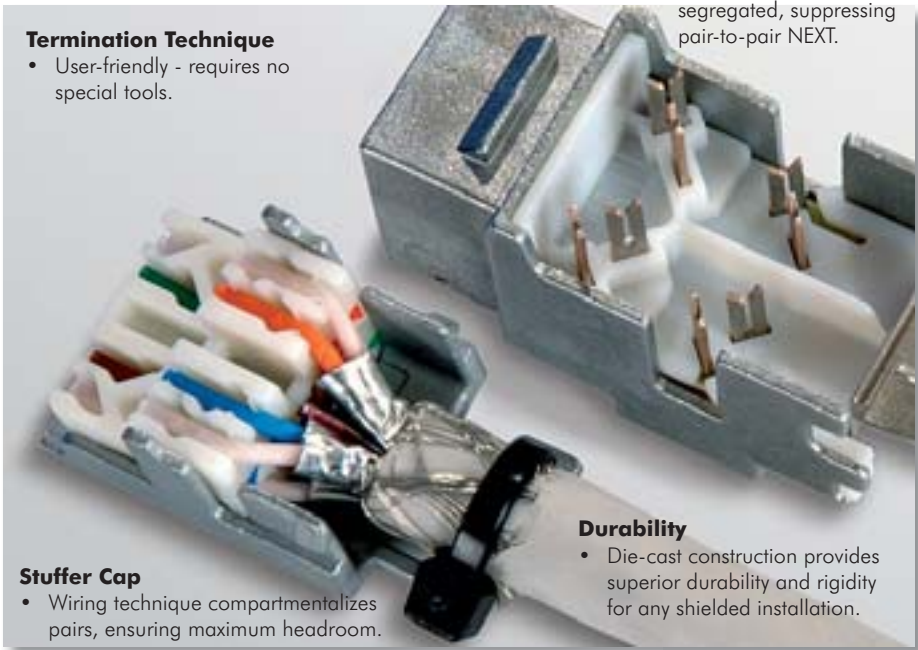

IDC Formation

- Allows each pair to be segregated, suppressing pair-to-pair NEXT.

Stuffer Cap

- Wiring technique compartmentalizes pairs, ensuring maximum headroom.

Durability

- Die-cast construction provides superior durability and rigidity for any shielded installation.



Quick Grounding

- SJ6 jacks can be directly connected to grounding cables.

HUBBELL Advantage

- Quick and Easy Terminal Grounding Connection.
- Tool Less Termination.
- Third-Party Tested and Verified.
- Bulk Packaged to Eliminate Excess Packing Waste.

NEXTSPEED® Shielded Jacks, Category 6/10GbE



The NEXTSPEED® SJ6 jack features inversely oriented right-angled IDC contacts. It is designed to deliver a high level of reliability and consistency. This IDC formation allows each pair to be segregated to suppress pair-to-pair NEXT. With its mechanical die cast construction design, the NEXTSPEED® SJ6 has the durability and EMI protection needed for any shielded installation.

Category	Pckg. Quantity	B-Wired Catalog No.	A-Wired Catalog No.
6	2	SJ62B ✓10G	SJ62A ✓10G
6	24	SJ624B ✓10G	SJ624A ✓10G
5e	2	SJ5EB	SJ5EA
5e	24	SJ5EB24	SJ5EA24

Shield Colored Dust Covers

Delivery: 100 per package.

Color	Blue	Black	Green	Orange	Yellow
Catalog No.	IDCSB	IDCSBK	IDCSGN	IDCSOR	IDCSY



Modular Jack Accessories



1-Punch XJ Termination Tool and Accessories

The "1-Punch" XJ Tool and XCELERATOR™ Jacks are made for each other. This tool should be used exclusively with XCELERATOR™ jacks. Additionally, it is necessary to use this with the HXTA termination aid.

XCELERATOR™ Jacks	Catalog No.
Description	
1-Punch tool with head, blades and HXTA termination aid	TX4P6A
1-Punch Ascent tool replacement head	TX4P6AH
1-Punch Ascent tool replacement blades	TX4P6ABL
1-Punch XJ tool with head, blades and HXTA termination aid	TX4P
1-Punch XJ replacement head	TX4PH
1-Punch XJ replacement blades	TX4PHBL
1-Pair 110 blade	TBLH
Punch down tool, 1-pair	TPDH
Hand termination aid "Jack Knuckles" XCELERATOR™ /Ascent	HXTA
Snap-X termination puck (Bag of 25)	HXTP25
Ascent termination puck	HXTP2A5



Jack Dust Covers



- Features/Benefits**
- Use with XCELERATOR™ modular jacks.
 - Mounts within the icon slots located above the RJ45 opening.
 - An icon can be housed on the dust cover in the center of RJ45 opening to provide port identification.

Specifications

- ◆ Material: Polypropylene.

NOTE: *Cannot be used with SJ Jack Series.*

Catalog. No. **HXJDC25**



Jack Icons



- Features/Benefits**
- Color-coded icons snap easily onto the jack nose.

Specifications

- ◆ ANSI/TIA-606-B compatible.
- ◆ Flame-retardant material UL 94V-0.

Icons are offered in packs of 100 blank or with a computer or telephone molded in. Customize each blank icon with our preprinted icon booklet. NOTE: *Cannot be used with SJ Jack Series.*



Color	Blank	Computer	Telephone
See Code below	IXX100	IXX100C	IXX100T

XX = Icon Color Options

BK =Black	B =Blue	BN =Brown	EI =Electric Ivory	GY =Gray	GN =Green
OR =Orange	P =Purple	R =Red	W =White	Y =Yellow	

Jack Labels, Pre-Printed

Pre-printed icon booklet containing assorted clear icon labels to be applied on blank icons (shown above - sold in pack of 5 books). Each booklet has 11 pages with numerous labels ranging from A to G, FAX to Data.

Text color	Catalog No.	Text color	Catalog. No.
Black	XPICONS	White	XPICONSW



Audio Video Connectors



Hubbell's expanded line of high quality Audio Video connectors provide multimedia configurations to the desktop as well as the telecommunications closet. Hubbell's extensive offerings of S-Video, XLR, 15-pin "VGA style", RCA, 9-pin serial port, 1/4" and 3.5mm stereo jacks, BNC and F connectors are provided in several different versions, delivering flexibility and ease-of-use to customize the work area to the exact configuration needed.

Sold in carton increments only. Carton contains - 25 keystone connectors (individually bagged).



RCA Connectors



RCA 110 Punch Down

Recommended cable: Category 3, 5, 5e or 6 UTP.

Insulator Color	Blue	Green	Red	White	Yellow
Black Housing	SFRC110B	SFRC110GN	SFRC110R	SFRC110W	SFRC110Y



RCA Solder Coupler Termination

Recommended cable: 14-28 AWG Mini-Coax.

Insulator	Black	Blue	Green	Orange	Red
Housing: Office White only	SFRC	SFRCBOW	SFRCGNOW	SFRCOROW	SFRCR

Insulator	White	Yellow			
Housing: Office White only	SFRCW	SFRCY			

Insulator	Black	Blue	Green	Orange	Red
All other colors see Color Chart below	SFRCXX	SFRCBXX	SFRCGNXX	SFRCORXX	SFRCRXX

Insulator	White	Yellow			
All other colors see Color Chart below	SFRCWXX	SFRCYXX			



RCA Gold Pass-through, F/F Coupler

Insulator Color	Black	Blue	Green	Orange	Red
Housing: Office White only	SFRCBKFF	SFRCBFFOW	SFRCGNFFOW	SFRCORFFOW	SFRCRFF

Insulator Color	White	Yellow			
Housing: Office White	SFRCWFF	SFRCYFF			

Insulator Color	Black	Blue	Green	Orange	Red
All other colors see Color Chart below	SFRCBKFFXX	SFRCBFFXX	SFRCGNFFXX	SFRCORFFXX	SFRCRFFXX

Insulator Color	White	Yellow			
All other colors see Color Chart below	SFRCWFFXX	SFRCYFFXX			



RCA Recessed Gold Pass-through, F/F Coupler

Insulator Color	Black	Blue	Green	Orange	Red
Housing see below	SFRCBKXX	SFRCBXX	SFRCRGNXX	SFRCRORXX	SFRCRRXX

Insulator Color	White	Yellow			
All other colors see Color Chart below	SFRCRXX	SFRCRYXX			

XX = Connector Color Options

AL=Almond	BK=Black	EI=Electric Ivory	GY=Gray	LA=Light Almond	OW=Office White	W=White
-----------	----------	-------------------	---------	-----------------	-----------------	---------



F-Type Connectors

F-Connector, Pass-Through, F/F Coupler

Housing Color	Almond	Light Almond	Black	Electric Ivory	Gray
Catalog No.	SFFALX	SFFLAX	SFFBX	SFFEX	SFFGX
Housing Color	Office White	White			
Catalog No.	SFFX	SFFWX			



F-Connector, Gold, Pass-Through, F/F Coupler

Housing Color	Almond	Light Almond	Black	Electric Ivory	Gray
Catalog No.	SFFGAL	SFFGLA	SFFGBK	SFFGEI	SFFGGY
Housing Color	Office White	White			
Catalog No.	SFFGOW	SFFGW			



F-Connector, Gold, Recessed, Pass-Through, F/F Coupler

Housing Color	Almond	Light Almond	Black	Electric Ivory	Gray
Catalog No.	SFGRFAL	SFGRFLA	SFGRFBK	SFGRFEI	SFGRFGY
Housing Color	Office White	White			
Catalog No.	SFGRFOW	SFGRFW			



RCA to F-Connector, Gold, Pass-Through, F/F Coupler

Housing Color	Almond	Light Almond	Black	Electric Ivory	Gray
Catalog No.	SFRFGAL	SFRFGLA	SFRFGBK	SFRFGEI	SFRFGGY
Housing Color	Office White	White			
Catalog No.	SFRFGOW	SFRFGW			



RG59 Male to RG6 Female Coupler, 10-pk

Use with Recessed F-Connector	
Catalog No.	RG59A10



F and RCA Plugs and Tools



Termination Type	Cable Type	No. of Pieces	Catalog No.
Compression	RG6	1	FRG625
Compression	RG59	1	FRG5925
Crimp	RG6	1	FRG6C25
Compression	RG59	1	RG59FC
Push on plug	RG59	1	RG59FPO



FRG625

Tools

Crimp Tool Frame (die-sets sold separately)	Catalog No.
	UCT
RG6 and RG59 Crimp Die-Set	CDTSRG659
RG6 and RG59 Compression Tool	COMPTRG659



UCT

COMPTRG659

Audio Video Connectors



S-Video Connectors



S-Video F/4-pin DIN Connector to 110 Termination

Housing Color	Almond	Black	Electric Ivory	Gray
Catalog No.	SFSV110AL	SFSV110BK	SFSV110EI	SFSV110GY
Housing Color	Office White	White		
Catalog No.	SFSV110OW	SFSV110W		



S-Video 4-pin DIN, Pass-Through, F/F Coupler

Housing Color	Almond	Black	Electric Ivory	Gray
Catalog No.	SFSVAL	SFSVBK	SFSVEI	SFSVGY
Housing Color	Office White	White		
Catalog No.	SFSVOW	SFSVW		

Stereo Jacks, 3.5mm



Stereo Jack, 3.5mm, Solder

Housing Color	Almond	Light Almond	Black	Electric Ivory	Gray
Catalog No.	SF35SJAL	SF35SJLA	SF35SJBK	SF35SJEI	SF35SJGY
Housing Color	Office White	White			
Catalog No.	SF35SJ	SF35SJW			



Stereo Jack, 3.5mm, Screw Terminal

Housing Color	Almond	Light Almond	Black	Electric Ivory	Gray
Catalog No.	SF35STAL	SF35STLA	SF35STBK	SF35STEI	SF35STGY
Housing Color	Office White	White			
Catalog No.	SF35STOW	SF35STW			



Stereo Jack, Pass-Through, F/F Coupler

Housing Color	Almond	Light Almond	Black	Electric Ivory	Gray
Catalog No.	SF35FFAL	SF35FFLA	SF35FFBK	SF35FFEI	SF35FFGY
Housing Color	Office White	White			
Catalog No.	SF35FFOW	SF35FFW			



Stereo Jack, Pass-Through, Gold, F/F Coupler

Housing Color	Almond	Light Almond	Black	Electric Ivory	Gray
Catalog No.	SF35GFFAL	SF35GFFLA	SF35GFFBK	SF35GFFEI	SF35GFFGY
Housing Color	Office White	White			
Catalog No.	SF35GFFOW	SF35GFFW			



Bulk 3.5mm Connectors, 10-Pack

	Solder	Feed-Through	Screw Termination
Catalog No.	35S10	35FF10	35ST10



Stereo Jack, 1/4", Solder

Housing Color	Almond	Light Almond	Black	Electric Ivory	Gray
Catalog No.	SF14SJAL	SF14SJLA	SF14SJBK	SF14SJEI	SF14SJGY
Housing Color	Office White	White			
Catalog No.	SF14SJOW	SF14SJW			



Gold Speaker Post Connectors and Banana Plugs

Speaker Post, Gold, Black, Screw Termination

Housing Color	Almond	Light Almond	Black	Electric Ivory	Gray
Catalog No.	SFSPGBKAL	SFSPGBKLA	SFSPGBKBK	SFSPGBKEI	SFSPGBKGY
Housing Color	Office White	White			
Catalog No.	SFSPGBK	SFSPGBKGW			



Speaker Post, Gold, Red, Screw Termination

Housing Color	Almond	Light Almond	Black	Electric Ivory	Gray
Catalog No.	SFSPGRAL	SFSPGRLA	SFSPGRBK	SFSPGREI	SFSPGRGY
Housing Color	Office White	White			
Catalog No.	SFSPGR	SFSPGRGW			



Speaker Banana Plugs, Gold, Screw Termination, 10-Packs

	Black	Red			
Catalog No.	SPPBK10	SPPR10			



BNC Connectors



BNC Connector, Pass-Through, F/F Coupler

Housing Color	Almond	Light Almond	Black	Electric Ivory	Gray
Catalog No.	SFBAL	SFBLA	SFBBK	SFBEI	SFBGY
Housing Color	Office White	White			
Catalog No.	SFBOW	SFBW			



BNC Connector, Gold, Pass-Through, F/F Coupler

Housing Color	Almond	Light Almond	Black	Electric Ivory	Gray
Catalog No.	SFBGAL	SFBGLA	SFBGBK	SFBGEI	SFBGGY
Housing Color	Office White	White			
Catalog No.	SFBGOW	SFBGW			



Blank Connectors, 10-Pack



Blank Connector

Housing Color	Black	Electric Ivory	Gray	Office White	White
Catalog No.	SFBB10	SFBEI10	SFBG10	SFB10	SFBW10



Blank Connector, Smooth

The smooth blank connectors are used with the NSP wall plates found on page B28.

Housing Color	Almond	Light Almond	Black	Gray	White
Catalog No.	SFSBAL10	SFSBLA10	SFSBBK10	SFSBGY10	SFSBW10



Audio Video Connectors

USB Connectors



USB Coupler, A to A, 2.0

Housing Color	Catalog No.
Blue	SFUSBAAB
Office White	SFUSBAAOW
White	SFUSBAAW



USB Coupler, A to B, 2.0 Reversible

Housing Color	Catalog No.
Blue	SFUSBABB
Office White	SFUSBABOW
White	SFUSBABW

6-Pin DIN Connectors



6-Pin, DIN, Keyboard, Pass-Thru, F/F Coupler

Catalog No.	SF6PK



6-Pin, DIN, Monitor, Pass-Thru, F/F Coupler

Catalog No.	SF6PM

Data Couplers



Category 6, Pass-Thru, F/F Coupler

Housing Color	Catalog No.
Black	SFC6BK
White	SFC6W



Category 5e, Pass-Thru, F/F Coupler

Housing Color	Catalog No.
Black	SFC5EBK
White	SFC5EW



Category 5e, Cross Over 10/100BASE-T, F/F Coupler

Housing Color	Catalog No.
Gray	SF5ECOGY

HUBBELL OptiChannel Keystone Adapters

LC Duplex, Flush Mount, Keystone Adapter



Phosphor Bronze Sleeves.

Color	Almond	Black	Electric Ivory	Gray	Lt. Almond	Office White	White
Catalog No.	SFFLCAL	SFFLCBK	SFFLCEI	SFFLCG	SFFLCLA	SFFLC	SFFLCW

Zirconia Sleeves.

Color	Almond	Black	Electric Ivory	Gray	Lt. Almond	Office White	White
Catalog No.	SFFLCSAL	SFFLCSBK	SFFLCSEI	SFFLCSG	SFFLCSLA	SFFLCS	SFFLCW

LC Duplex, Keystone Adapter



Phosphor Bronze Sleeves.

Color	Almond	Black	Electric Ivory	Gray	Lt. Almond	Office White	White
Catalog No.	SFLCAL	SFLCBK	SFLCEI	SFLCG	SFLCLA	SFLC	SFLCW

Zirconia Sleeves.

Color	Almond	Black	Electric Ivory	Gray	Lt. Almond	Office White	White
Catalog No.	SFLCSAL	SFLCSBK	SFLCSEI	SFLCSG	SFLCSLA	SFLCS	SFLCSW

HUBBELL OptiChannel Keystone Adapters



SC Simplex, Flush Mount, Keystone Adapter

Phosphor Bronze Sleeves.

Color	Almond	Black	Electric Ivory	Gray	Lt. Almond	Office White	White
Catalog No.	SFFSCAL	SFFSCBK	SFFSCEI	SFFSCG	SFFSCLA	SFFSC	SFFSCW

Zirconia Sleeves.

Color	Almond	Black	Electric Ivory	Gray	Lt. Almond	Office White	White
Catalog No.	SFFSCSAL	SFFSCSBK	SFFSCSEI	SFFSCSG	SFFSCSLA	SFFSCS	SFFSCSW



SC/APC, Simplex, Keystone Adapter

Zirconia sleeves.

Color	Almond	Black	Electric Ivory	Gray	Lt. Almond	Office White	White
Catalog No.	SFSCAAL	SFSCABK	SFSCAEI	SFSCAGY	SFSCALA	SFSCAOW	SFSCAW



SC Simplex, Keystone Adapter

Phosphor Bronze sleeves.

Color	Almond	Black	Electric Ivory	Gray	Lt. Almond	Office White	White
Catalog No.	SFSCAL	SFSCBK	SFSCEI	SFSCG	SFSCLA	SFSC	SFSCW

Zirconia sleeves.

Color	Almond	Black	Electric Ivory	Gray	Lt. Almond	Office White	White
Catalog No.	SFSCSAL	SFSCSBK	SFSCSEI	SFSCSG	SFSCSLA	SFSCS	SFSCSW



MT-RJ, Flush Mount, Keystone Adapter

MM.

Color	Almond	Black	Electric Ivory	Gray	Lt. Almond		
Catalog No.	FAMTRJKAL	FAMTRJKBK	FAMTRJKEI	FAMTRJG	FAMTRJLA		

Color	Office White	White					
Catalog No.	FAMTRJK	FAMTRJKW					



MT-RJ, Keystone Adapter

MM. Delivery: 25-carton.

Color	Almond	Black	Electric Ivory	Gray	Lt. Almond		
Catalog No.	SFMTRJAL	SFMTRJBK	SFMTRJEI	SFMTRJG	SFMTRJLA		

Color	Office White	White					
Catalog No.	SFMTRJ	SFMTRJW					



ST-style to SC Simplex, Keystone Adapter

Phosphor Bronze sleeves.

Color	Almond	Black	Electric Ivory	Gray	Lt. Almond	Office White	White
Catalog No.	SFSCSTAL	SFSCSTBK	SFSCSTEI	SFSCSTG	SFSCSTLA	SFSCST	SFSCSTW

Zirconia sleeves.

Color	Almond	Black	Electric Ivory	Gray	Lt. Almond	Office White	White
Catalog No.	SFSCSTSAL	SFSCSTSBK	SFSCSTSEI	SFSCSTSG	SFSCSTSLA	SFSCSTS	SFSCSTSW



ST-style Keystone Adapter

Phosphor Bronze sleeves.

Color	Almond	Black	Electric Ivory	Gray	Lt. Almond	Office White	White
Catalog No.	SFSTAL	SFSTBK	SFSTEI	SFSTG	SFSTLA	SFST	SFSTW

Zirconia sleeves.

Color	Almond	Black	Electric Ivory	Gray	Lt. Almond	Office White	White
Catalog No.	SFSTSAL	SFSTSBK	SFSTSEI	SFSTSG	SFSTSLA	SFSTS	SFSTSW

iSTATION™ products provide a consistent and practical solution for delivering all types of connections. The **iSTATION™** system tackles convergence by locating AV Solutions where you need them: On the wall, In the wall, On the floor, In the floor, In the table, On a rack, In a cabinet.

The **iSTATION™** approach makes adding a connection straight forward and effortless all the while maintaining a clean, uniform look.











Specifications

- ◆ ANSI/TIA-606-B station labeling capability.
- ◆ UL and cUL listed.
- ◆ Flush mounting with box eliminators.
- ◆ Front loading installation.

HUBBELL
Advantage

- Most Extensive Audio Video and Voice/Data Offering in the Industry.
- Simple Field Configuration.
- Provides One Solution for all Delivery System Applications.
- AV Assemblies Made to Length Eliminating Cable Waste.

Extensive Voice/Data/Audio Video Applications.

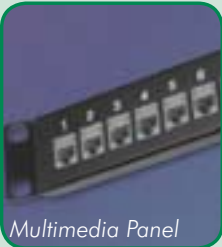
<p>In-Wall</p>	<p>iSTATION™ Modular Frames See page B22</p> <ul style="list-style-type: none"> • Voice/Data/Video. • Audio in a single Box. • High-density. • Modular Solutions. 	 <p>Keystone Plate</p>  <p>iSTATION™ Frame</p>
	<p>MULTI-CONNECT® Wall Boxes See page B24</p> <ul style="list-style-type: none"> • Multi-Service. • Voice/Data/Video. • Power and Low-Voltage. 	 <p>MULTI-CONNECT®</p>
<p>On-Wall</p>	<p>POLYTRAK® Raceway See Section J</p> <ul style="list-style-type: none"> • Single, 2-Channel, 3-Channel. • Low-Voltage or Power Applications. • Metal and Non-metallic. 	 <p>Raceway</p>  <p>Furniture Plate</p>
<p>In-Floor</p>	<p>3-Service Concrete Floor Box, See Section I</p> <p>Large Capacity Concrete Floor Box, See Section I</p> <p>Raised Access Floor Box See Section I</p>	 <p>Floor Box</p>  <p>Large Capacity Floor Box</p>
<p>Through-Floor</p>	<p>Fire-Rated Poke Throughs See Section I</p> <ul style="list-style-type: none"> • Power and Low-Voltage. • Voice/Data/Video. • Retrofit and Expansions. • Furniture Feed Capability. 	 <p>Poke-Thru</p>
<p>In Rack or Cabinet</p>	<p>UDX Multimedia Panels See page E10</p> <ul style="list-style-type: none"> • Angled Panels. • UDX Multimedia Panels. • Jack Panel Kits. • Category 6A, 6, 5e, 3 - AV and Fiber Optic applications. 	 <p>Multimedia Panel</p>

HUBBELL iStation Audio Video Modules



Solder Audio Video Modules



RCA Component Video with Left/Right Audio or RGBHV, Solder, 1.5 Unit

Housing Color	Almond	Black	Electric Ivory	Gray
Catalog No.	IMCRS15AL	IMCRS15BK	IMCRS15EI	IMCRS15GY

Housing Color	Office White	White
Catalog No.	IMCRS15OW	IMCRS15W



RCA Component, Video, Solder, 1 Unit

Housing Color	Almond	Black	Electric Ivory	Gray
Catalog No.	IMCRS1AL	IMCRS1BK	IMCRS1EI	IMCRS1GY

Housing Color	Office White	White
Catalog No.	IMCRS1OW	IMCRS1W



RCA Composite Video with Left/Right Audio, Solder, 1 Unit

Housing Color	Almond	Black	Electric Ivory	Gray
Catalog No.	IM3RS1AL	IM3RS1BK	IM3RS1EI	IM3RS1GY

Housing Color	Office White	White
Catalog No.	IM3RS1OW	IM3RS1W



RCA Composite Video, 3.5mm Stereo Audio Jack, Solder, 1 Unit

Housing Color	Almond	Black	Electric Ivory	Gray
Catalog No.	IMRSJ1AL	IMRSJ1BK	IMRSJ1EI	IMRSJ1GY

Housing Color	Office White	White
Catalog No.	IMRSJ1OW	IMRSJ1W

Gold Feed-Through Audio Video Modules



RCA Component, Video, Gold, Pass-Through, F/F Coupler, 1 Unit

Housing Color	Almond	Black	Electric Ivory	Gray
Catalog No.	IMCRF1AL	IMCRF1BK	IMCRF1EI	IMCRF1GY

Housing Color	Office White	White
Catalog No.	IMCRF1OW	IMCRF1W



RCA Composite, Video w/ Left/Right Audio, Gold, Pass-Through, F/F Coupler, 1 Unit

Housing Color	Almond	Black	Electric Ivory	Gray
Catalog No.	IM3RF1AL	IM3RF1BK	IM3RF1EI	IM3RF1GY

Housing Color	Office White	White
Catalog No.	IM3RF1OW	IM3RF1W



RCA Left/Right Audio with 3.5mm Stereo Audio Jack, Gold, Feed-Through, F/F Coupler, 1 Unit

Housing Color	Almond	Black	Electric Ivory	Gray
Catalog No.	IM35AR1AL	IM35AR1BK	IM35AR1EI	IM35AR1GY

Housing Color	Office White	White
Catalog No.	IM35AR1OW	IM35AR1W

Gold Speaker Posts Modules and Banana Plugs



Speaker Post, Gold, Black and Red, Screw Termination

Housing Color	Almond	Black	Electric Ivory	Gray	Office White	White
Catalog No.	IMSP1AL	IMSP1BK	IMSP1EI	IMSP1GY	IMSP1OW	IMSP1W

Speaker Banana Plugs, Gold, Screw Termination, 10-Packs

	Black	Red
Catalog No.	SPPBK10	SPPR10



110 Audio Video Modules



RCA Component Video to 110 Termination, 1 Unit
75' max. High Definition, Category 3, 5, 5e, 6 UTP

Housing Color	Almond	Black	Electric Ivory	Gray
Catalog No.	IMCR1101AL	IMCR1101BK	IMCR1101EI	IMCR1101GY
Housing Color	Office White	White		
Catalog No.	IMCR1101OW	IMCR1101W		



S-Video, with Left/Right RCA Audio to 110 Termination, 1 Unit
100' max. Category 3, 5, 5e, 6 UTP

Housing Color	Almond	Black	Electric Ivory	Gray
Catalog No.	IMSR1101AL	IMSR1101BK	IMSR1101EI	IMSR1101GY
Housing Color	Office White	White		
Catalog No.	IMSR1101OW	IMSR1101W		



S-Video, 3.5mm Stereo Audio Jack to 110 Termination, 1 Unit
100' max. Category 3, 5, 5e, 6 UTP

Housing Color	Almond	Black	Electric Ivory	Gray
Catalog No.	IMSV351101AL	IMSV351101BK	IMSV351101EI	IMSV351101GY
Housing Color	Office White	White		
Catalog No.	IMSV351101OW	IMSV351101W		



RCA Composite Video with Left/Right Audio to 110 Termination, 1 Unit
100' max. Category 3, 5, 5e, 6 UTP

Housing Color	Almond	Black	Electric Ivory	Gray
Catalog No.	IMR1101AL	IMR1101BK	IMR1101EI	IMR1101GY
Housing Color	Office White	White		
Catalog No.	IMR1101OW	IMR1101W		



RCA Left/Right Audio 110 Termination, 1 Unit
100' max. Category 3, 5, 5e, 6 UTP

Housing Color	Almond	Black	Electric Ivory	Gray
Catalog No.	IMAR1101AL	IMAR1101BK	IMAR1101EI	IMAR1101GY
Housing Color	Office White	White		
Catalog No.	IMAR1101OW	IMAR1101W		

15-pin VGA, 9-pin Screw Terminal and Gender Changer Connections



HD 9-pin F/F Coupler
10-Pack
Catalog No. **9GC10**



HD 9-pin Screw Term
10-Pack
Catalog No. **9ST10**



HD 15-pin F/F Coupler
10-Pack
Catalog No. **15GC10**



HD 15-pin Screw Term
10-Pack
Catalog No. **15ST10**

HUBBELL iStation Audio Video Modules



Pro AV Panel Mount Connectors and Modules



Blank AV Panel Mount Module, 1.5 Unit, 10-Pack

Housing Color	Almond	Black	Electric Ivory	Gray	Office White	White
Catalog No.	IMAVB15AL	IMAVB15BK	IMAVB15EI	IMAVB15GY	IMAVB15OW	IMAVB15W

XLR 3-pin, Screw Termination



Female, 10-Pack
Catalog No. **XLRST10**

XLR 3-pin, Solder



Female, 10-Pack
Catalog No. **XLR10**

1/4" Stereo Jack



Solder, Female, 10-Pack
Catalog No. **14S10**

SPEAKON®



2-pole, Female, 10-Pack
Catalog No. **SC10**

USB Connection



Coupler, 10-Pack
Catalog No. **USB10**

IEEE 1394 Fire Wire™



Connection Coupler, 10-Pack
Catalog No. **139410**

NOTE: See page E10 for AVI and Pro AV Panels. All Pro-AV Connectors and Modules are available in 10-Packs only. FireWire™ is a trademark of Apple.

Loaded Pro AV Modules



Mini XLR, Solder, 1 Unit

Housing Color	Almond	Black	Electric Ivory	Gray	Office White	White
Catalog No.	IMXLR1AL	IMXLR1BK	IMXLR1EI	IMXLR1GY	IMXLR1OW	IMXLR1W



15-pin Screw Term, 3.5mm Stereo Jack Screw Term, XLR Screw Term, 2 Unit

Housing Color	Almond	Black	Electric Ivory	Gray	Office White	White
Catalog No.	IM153X2AL	IM153X2BK	IM153X2EI	IM153X2GY	IM153X2OW	IM153X2W

DVI Connectors, Converters and Modules



Blank DVI Module, 1.5 Unit

Housing Color	Almond	Black	Electric Ivory	Gray	Office White	White
Single	IMBDVI15AL	IMBDVI15BK	IMBDVI15EI	IMBDVI15GY	IMBDVI15OW	IMBDVI15W
10-Pack	IMBDVI1015AL	IMBDVI1015BK	IMBDVI1015EI	IMBDVI1015GY	IMBDVI1015OW	IMBDVI1015W



DVI-I F/F Coupler

10-Pack
Catalog No. **DVI10**



DVI-I F/F Coupler

1-Pack
Catalog No. **DVI1**



DVI to 15-pin

F/F Coupler, 1-Pack
Catalog No. **DVI151**



DVI to HDMI

F/F Coupler, 1-Pack
Catalog No. **DVIHDMI1**

Performance

- 24AWG custom 1.3 HDMI cable designed for full 1080p video and flawless audio.

Versatility

- HDMI connection is supported in all Hubbell iSTATION™ products which include Work Station, Delivery, and Cross Connect.

Simplicity

- The HDMI plug-n-play feature saves valuable installation and testing time in the field.

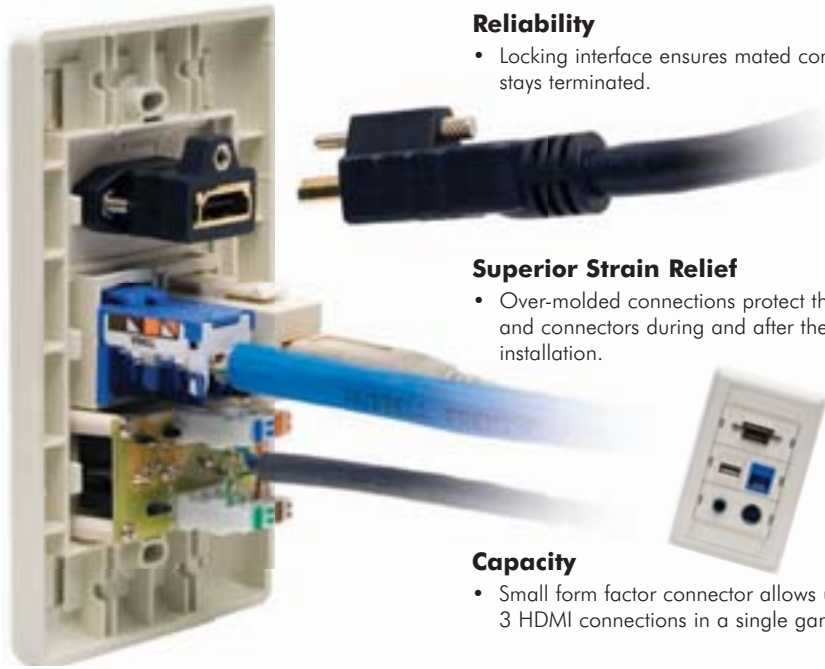

Reliability

- Locking interface ensures mated connection stays terminated.

Superior Strain Relief

- Over-molded connections protect the cable and connectors during and after the installation.

Capacity

- Small form factor connector allows up to 3 HDMI connections in a single gang.

Specifications

- ◆ Connector: 2 micro-inch Gold-plated.
- ◆ Version: 1.3.
- ◆ Audio Signal: PCM, DVD-Audio, Super Audio CD, Dolby True HD, DTS-HD Master Audio.
- ◆ Video Signal: 480i, 480p, 720p, 1080i, 1080p.
- ◆ Pins: 19.



HUBBELL
Advantage

- Locking Connection Interface.
- 3" Application Tail Provides Flexibility and Ease-of-Use for Installations with Capacity Issues.
- Full High Definition 1080p Signal Transmission, HDMI 1.3.
- Assemblies Made to Length Eliminates Cable Waste.

HDMI Horizontal Active and Non-Active Horizontal Patch Cords



Patch Cords, 24AWG		Horizontal Cords, 24AWG (connector-to-connector)		Link Cords, 24AWG (connector-to-device)		Coupler Cords, 24AWG (coupler-to-device)	
Description	Catalog No.	Description	Catalog No.	Description	Catalog No.	Description	Catalog No.
3', Black	HDPC03BK	Black	HDH**BK	Black	HDL**BK	Black	HDC**BK
6', Black	HDPC06BK						

** = Length: "10"=10'; "15"=15'; "20"=20'; "25"=25'; "30"=30'. Black and non-plenum only.

HDMI Connectors



HDMI Coupler	HDMI 3" Tail	HDMI Decorator Frame
Gold, Female-Female	Gold, Female-Female	Gold, Female-Female
1-pk	1-pk	1-port
10-pk	10-pk	2-port
Catalog No. HDMIC1 HDMIC10	Catalog No. HDMIT1 HDMIT10	Catalog No. NS801XX NS802XX

XX = Frame Color Options

AL=Almond	BK=Black	EI=Electric Ivory	GY=Gray	LA=Light Almond	OW=Office White	W=White
-----------	----------	-------------------	---------	-----------------	-----------------	---------

Plug-n-Play X-END™ AV System

Performance

- Custom AV cable is designed for minimal signal loss delivering a transparent video and flawless audio.

Flexibility

- Supports multiple applications and connector configurations.

Simplicity

- The X-END™ plug-n-play feature saves valuable installation and testing time in the field.

Versatility

- The uniqueness of X-END™ allows the user to swap out application patch cords and tails utilizing the same connection without changing the horizontal runs.

Small Form Factor

- The X-END™ horizontal cable runs can easily be pulled through 3/4" conduit without any issue.

Capacity

- Allows up to 6 keystone connections or 3 1 Unit modules in a single gang delivering the equivalent of up to 30 connectors in a single plate.

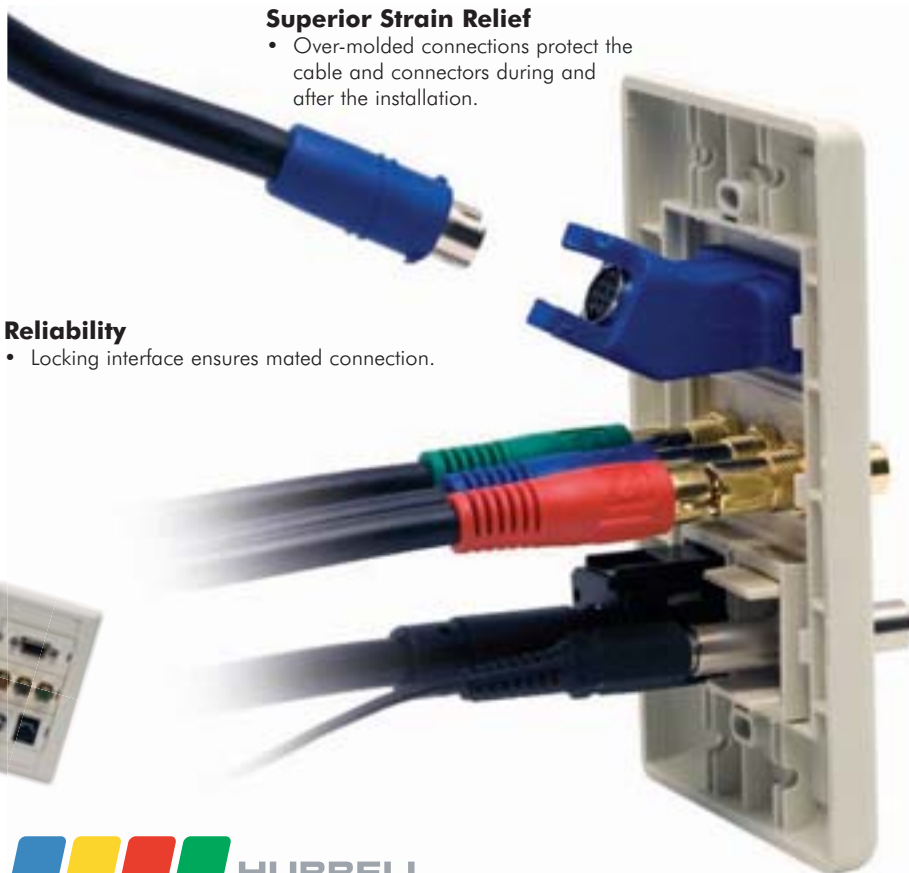

Superior Strain Relief

- Over-molded connections protect the cable and connectors during and after the installation.

Reliability

- Locking interface ensures mated connection.

Specifications

- ◆ Connector contacts
15-pin: 2 micro-inch Gold-plated.
8-pin: Brass, Nickel-plated.
- ◆ Module material: Flame Retardant Polymer, rated UL 94V-0.
- ◆ Cable type: 28AWG, 75 Ohm.
5 mini Coax: Plenum
5 mini Coax: Non-Plenum
100% factory terminated and tested.



HUBBELL Advantage

- Locking Connection Interface.
- 3" Application Tail Provides Flexibility and Ease-of-Use for Installations with Capacity Issues.
- Up to 1080i RGB (Component) Transmission.
- Assemblies Made to Length Eliminates Cable Waste.

AV Plug-n-Play Horizontal Runs



Description	Catalog No.
Audio Video, 8-pin Non-Plenum, Black	VGA6XXBK
Audio Video, 8-pin Plenum, Black	VGA6PXXBK

XX = Length: "05" = 5'; "10" = 10'; "15" = 15'; "20" = 20'; "25" = 25'; "30" = 30'; "35" = 35'; "40" = 40'; "45" = 45'; "50" = 50'; "55" = 55'; "60" = 65'; "70" = 70'; "75" = 75'; "80" = 80'; "85" = 85'; "90" = 90'; "95" = 95'; "100" = 100'.

* Maximum supported distance varies by application and resolution. Refer to X-END™ brochure for details.



AV Plug-n-Play 8-Pin Keystone Connectors



Housing Color	Black	Blue	Brown	Electric Ivory	Gray	Green
Catalog No.	SFAVCBK	SFAVCB	SFAVCBN	SFAVCEI	SFAVCGY	SFAVCGN
Housing Color	Office White	Orange	Red	White	Yellow	
Catalog No.	SFAVCOW	SFAVCOR	SFAVCR	SFAVCW	SFAVCY	





AV Plug-n-Play 8-Pin iSTATION™ Modules

Audio Video 8-pin (F)				
Description	3 RCA Component Video, 1 Unit	S-Video with 2 RCAs Left/Right Audio, 1 Unit	S-Video, 3.5mm 1 Unit	3 RCA Composite Video with Left/Right Audio, 1 Unit
Catalog No.	IMCR81XX	IMSRA81XX	IMS3581XX	IMR8P1XX
Audio Video 8-pin (F)				
Description	3 RCA Component Video w/S/PDIF, 1.5 Unit	3 RCA Component Video with Left/Right Audio, 1.5 Unit	3 RCA Composite Video w/S-Video, 1.5 Unit	3 RCA Component with 3.5mm, 1.5 Unit
Catalog No.	IMCRD815XX	IMCAR815XX	IMSRC815XX	IMC35815XX
Audio 8-pin (F)			Video 8-pin (F)	
Description	XLR 3-pin Male, 3.5mm 1.5 Unit	XLR 3-pin Female, 3.5mm 1.5 Unit	Description	3 RCA Component with S-Video, 1.5 Unit
Catalog No.	IM3XM815XX	IM3XF815XX	Catalog No.	IMSCR815XX
				Description
				5-BNC RGBHV, 1.5 Unit
				Catalog No.
				IMB815XX

XX = Module Color Options

AL=Almond	BK=Black	EI=Electric Ivory	GY=Gray	LA=Light Almond	OW=Office White	W=White
-----------	----------	-------------------	---------	-----------------	-----------------	---------

AV Plug-n-Play X-END™ Application Patching Runs



Description	Catalog No.
Audio Video, 8-pin Female, S-Video with 3.5mm	AVS35XX
Audio Video, 8-pin Female, S-Video with 2 RCA L/R Audio	AVSRAXX
Audio Video, 8-pin Female, 3 RCA Composite Video with L/R Audio	AVRCXX
Video, 8-pin Female, 3 RCA Component Video	AVCRXX
Audio Video, 8-pin Female, 3 RCA Component Video with S/PDIF	AVCRDXX
Audio Video, 8-pin Female, 5 RCA Component Video with L/R Audio or RGBHV	AVCARXX
Video, 8-pin Female, 3 RCA Component with S-Video	AVSCRXX
Audio Video, 8-pin Female, S-Video, 3 RCA Composite Video with L/R Audio	AVSRCXX
Audio Video, 8-pin Female, 3 RCA Component with 3.5mm Stereo Jack	AVC35XX
Video, 8-pin Female, 5-BNC RGBHV	AVBXX
Audio, 8-pin Female, XLR 3-pin Male, 3.5mm Stereo Jack	AV3XMXX
Audio, 8-pin Female, XLR 3-pin Female, 3.5mm Stereo Jack	AV3XFXX



XX = Length: "05" = 5'; "10" = 10'; Male, 8-pin; "T1" = 1'; Female, 8-pin.

VGA Plug-n-Play X-end Connections, 15-Pin (F) to 8-Pin (F)



The most innovative approach to VGA termination, saving valuable time on the job site.

Quantity	Straight 180°	Angled 45°	Angled 90°	8" Tail	15-pin Male to 8-pin Female 8" Tail Non-Plenum	15-pin Male to 8-pin Female 8" Tail Plenum
1-Pack	15S6P1	15A6P1	15N6P1	15T6P1	15M6P1	15MP6P1
10-Pack	15S6P10	15A6P10	15N6P10	15T6P10	15M6P10	15MP6P10

AV Cable Latching Boot with Label Field



Use for application instructions.

Description	Catalog No. 1-pk	Catalog No. 10-pk
AV Cable Latching Boot with Label Field	CB1	CB10

Front-Loading Frames and Bezels



iSTATION™ Raceway Bezel

HUBBELL
Advantage

- Accommodates industry's most extensive line of AV modules.
- Front-loading access simplifies installation.
- Application customizing at the work station.
- Allows for future upgrades.

Features/Benefits

- Flush Keystone mounting.
- High density port count.
- Field configurable.
- UL and cUL listed.
- Flush mounting with box eliminators.

iSTATION™ Modular Face Plate Frames

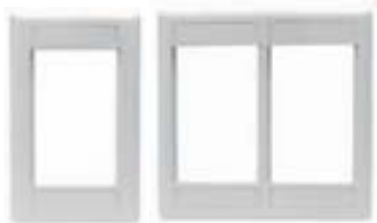

The IMF series accept any modules in 3 unit combinations for single-gang; and 6 unit combinations for double-gang applications. Start by selecting a frame and then the required mix of modules.

	IMF Plate Frame 1-gang	IMF Plate Frame 2-gang
Unit Package	1 per Bag	1 per Bag
Order Qty.	Carton of 20	Carton of 10
Color	Catalog No.	Catalog No.
See below	IMF1XX	IMF2XX



iSTATION™ Plates, Stainless Steel



IMS1

IMS2

Gang	1-Gang	2-Gang	3-Gang	4-Gang
Catalog No.	IMS1	IMS2	IMS3	IMS4



Delivery Bezels and Modules



KPIMBZOW HWAPLOW HBLIMFGY

	Raceway Bezel	iSTATION™ Bezel for Third-Party Raceway	MULTICONNECT® and Furniture Boxes
Unit Package	1 per Bag	1 per Bag	1 per Bag
Color	Catalog No.	Catalog No.	Catalog No.
Black	-	-	HBLIMFBK
Electric Ivory	-	-	HBLIMFEI
Gray	KPIMBZGY	HWAPLGY	HBLIMFGY
Office White	KPIMBZOW	HWAPLOW	-
White	KPIMBZW	HWAPLW	HBLIMFW



Integration Module, 2-port



HWM2KI10

HWM2KGY10

Delivery: 10 Integration Modules, unloaded.		Catalog No.
Ports	Color	
2	Ivory (Equivalent to Hubbell Office White)	HWM2KI10
2	Gray	HWM2KGY10
2	White	HWM2KW10



XX = Plate Color Options

AL=Almond	BK=Black	EI=Electric Ivory	GY=Gray	LA=Light Almond	OW=Office White	W=White
-----------	----------	-------------------	---------	-----------------	-----------------	---------



iSTATION™ Unloaded Modules

	KEYSTONE 1-port, Flat 1 Unit	KEYSTONE 2-port, Flat 1 Unit	KEYSTONE 1-port, Angled 1.5 Unit	KEYSTONE 2-port, Angled 1.5 Unit	SC ANGLED 1 Duplex 1.5 Unit	SC ANGLED 2 Duplex 2 Unit
Color	Catalog No.	Catalog No.	Catalog No.	Catalog No.	Catalog No.	Catalog No.
See below	IM1K1XX	IM2K1XX	IM1KA15XX 10G	IM2KA15XX 10G	IM1SCA15XX	IM2SCA2XX

	BLANK 0.5 Unit	BLANK 1 Unit	BLANK 1.5 Unit	KEYSTONE Recessed angle 1-Port, 1.5 Unit	KEYSTONE Recessed angle 2-Port, 1.5 Unit
Color	Catalog No.	Catalog No.	Catalog No.	Catalog No.	Catalog No.
See below	IMB05XX	IMB1XX	IMB15XX	IM11A15XX	IM21A15XX



Blank 15-pin/9-pin HDMI iSTATION™ Modules and Frames

Blank, 1U HD15/9-pin or HDMI	Blank Angled, 1.5U HD15/9-pin or HDMI	Blank, 1.5U HD15/9-pin or HDMI with 3.5mm Stereo Jack	Blank, 2U HD15/9-pin or HDMI with 3.5mm SJ+AV Conn	Blank Decorator Frame HD15/9-pin or HDMI 1-Gang
IMBDS1XX	IMBDSA15XX	IMB15315XX	IMB153X2XX	ISFB15XX

The iSTATION™ Frames accept 3 iSTATION™ 3 Units of module combinations in a Single-gang opening. See below for details.

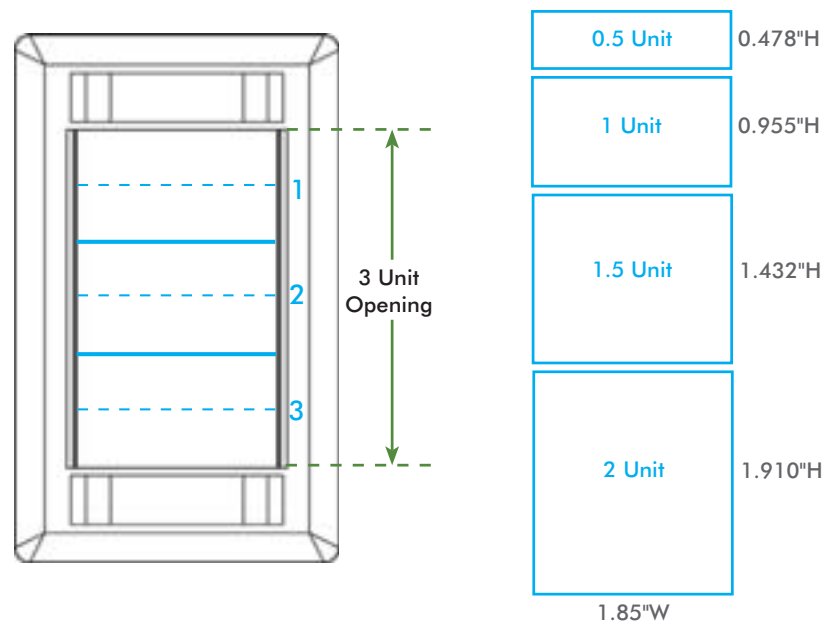

Module Color Options

AL=Almond	BK=Black	EI=Electric Ivory	GY=Gray	LA=Light Almond	OW=Office White	W=White
-----------	----------	-------------------	---------	-----------------	-----------------	---------

MULTI-CONNECT® Recessed Wall Boxes

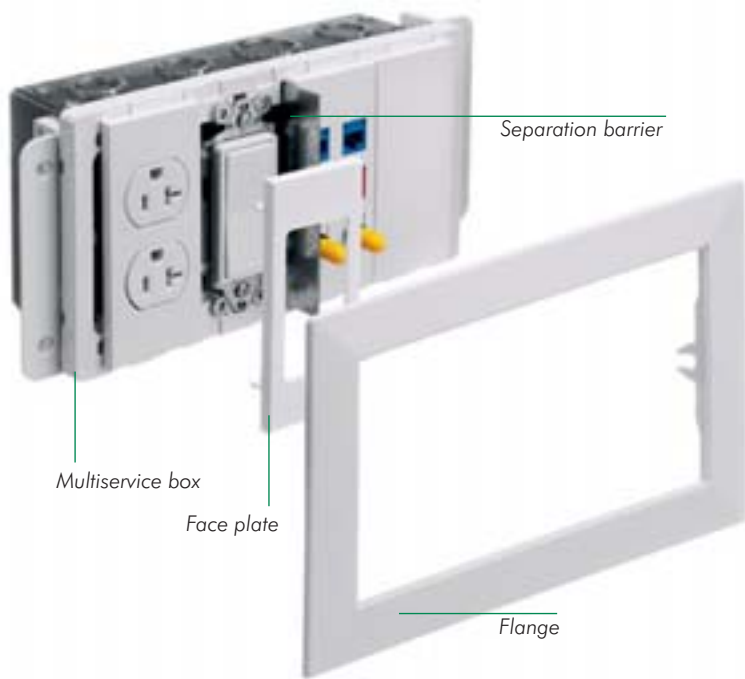

Hubbell MULTI-CONNECT® Boxes provide a versatile "in the wall" solution for single and multi-service applications. Available in 1-, 2-, 3-, 4- and 6-gang boxes, barriers for separation and power and low voltage services, along with a wide variety of modular face plates and wall flanges to match office decor.

Features/Benefits

- Blank face plate allows for expansion in future applications.
- Combination knockouts support various cable fill requirements.
- Barriers available to provide separation between power and low voltage.
- Wall flange snaps onto box and assures clean appearance.

Specifications

- ◆ Material
 - Recessed wall box: 16 ga. pre-galvanized steel.
 - Device mounting platform: PVC.
- ◆ Adjustable stud mounting bracket for 1/2", 5/8", 1" or 1 1/4" wall board.



Multi-Service Recessed Wall Boxes



Gang	Height	Width	Depth	Access Type	Location	Qty.	Size	Catalog No.
1	4.44" (112.8)	2.56" (65)	2.75" (69.8)	Knockout	Top & bottom	1	1/2" x 3/4"	HBLWSCS1
2	4.44" (112.8)	4.56" (115.8)	2.75" (69.8)	Knockout	Top & bottom	2	1/2" x 3/4"	HBLWSCS2
3	4.44" (112.8)	6.56" (166.6)	2.75" (69.8)	Knockout	Top & bottom	3	1/2" x 3/4"	HBLWSCS3
4	4.44" (112.8)	8.56" (217.4)	2.75" (69.8)	Knockout	Top & bottom	3	1/2" x 3/4"	HBLWSCS4
6	4.44" (112.8)	12.56" (319)	2.75" (69.8)	Knockout	Top & bottom	4	1/2" x 3/4"	HBLWSCS6
				Knockout	Top & bottom	1	3/4" x 1"	HBLWSCSBW

Low-Voltage Recessed Wall Boxes



Gang	Height	Width	Depth	Access Type	Location	Qty.	Size	Catalog No.
2	4.88" (123.8)	4.75" (120.7)	3.5" (88.9)	Opening	Top & bottom	1	2"	HBLWSCS2MMO ✓10G
3	4.88" (123.8)	6.75" (171.4)	3.5" (88.9)	Knockout	Side	1	1 1/4"	HBLWSCS3MMO ✓10G
				Opening	Top	1	1 1/4"	
				Knockout	Top	4	1/2" x 3/4"	
				Opening	Bottom	1	2"	
4	4.88" (123.8)	9.25" (235)	3.5" (88.9)	Knockout	Side	1	1 1/4"	HBLWSCS4MMO ✓10G
				Opening	Top	2	1 1/4"	
				Knockout	Top	4	1/2" x 3/4"	
				Opening	Bottom	1	2"	
				Knockout	Bottom	1	1/2" x 3/4"	
				Knockout	Bottom	1	3/4" x 1"	
6	4.88" (123.8)	13.25" (336.6)	3.5" (88.9)	Knockout	Side	1	1 1/4"	HBLWSCS6MMO ✓10G
				Opening	Top	3	1 1/4"	
				Knockout	Top	6	1/2" x 3/4"	
				Opening	Bottom	2	2"	
				Knockout	Bottom	1	1/2" x 3/4"	
				Knockout	Bottom	1	3/4" x 1"	

Wall Box Flanges, Trim Rings



Trim Ring, 1-Gang

Color	Catalog No.
Black	HBLTRIM1WBK
Gray	HBLTRIM1WGY
Ivory	HBLTRIM1WI
White	HBLTRIM1WW



HBLTRIM1WW

Trim Ring, 4-Gang

Color	Catalog No.
Black	HBLTRIM4WBK
Gray	HBLTRIM4WGY
Ivory	HBLTRIM4WI
White	HBLTRIM4WW



HBLTRIM4WW

Trim Ring, 2-Gang

Color	Catalog No.
Black	HBLTRIM2WBK
Gray	HBLTRIM2WGY
Ivory	HBLTRIM2WI
White	HBLTRIM2WW



HBLTRIM2WW

Trim Ring, 6-Gang

Color	Catalog No.
Black	HBLTRIM6WBK
Gray	HBLTRIM6WGY
Ivory	HBLTRIM6WI
White	HBLTRIM6WW



HBLTRIM6WW

Trim Ring, 3-Gang

Color	Catalog No.
Black	HBLTRIM3WBK
Gray	HBLTRIM3WGY
Ivory	HBLTRIM3WI
White	HBLTRIM3WW



HBLTRIM3WW

Modular Face Plates



Plates available in either a snap in, screw-less version, or with standard screws.

iSTATION™

Color	Catalog No. with Screws	Catalog No. Snap In
Black	HBLIMFSBK	HBLIMFBK
Gray	HBLIMFSGY	HBLIMFGY
Elec. Ivory	HBLIMFSI	HBLIMFI
White	HBLIMFSW	HBLIMFW



HBLIMFGY

Keystone

Color	Catalog No. with Screws	Catalog No. Snap In
Black	HBL317SBK	HBL317BK
Gray	HBL317SGY	HBL317GY
Elec. Ivory	HBL317SI	HBL317I
White	HBL317SW	HBL317W



HBL317W

Decorator

Color	Catalog No. with Screws	Catalog No. Snap In
Black	HBLDE301SBK	HBLDE301BK
Gray	HBLDE301SGY	HBLDE301GY
Elec. Ivory	HBLDE301SI	HBLDE301I
White	HBLDE301SW	HBLDE301W



HBLDE301W

Duplex

Color	Catalog No. with Screws	Catalog No. Snap In
Black	HBLST302SBK	HBLST302BK
Gray	HBLST302SGY	HBLST302GY
Elec. Ivory	HBLST302SI	HBLST302I
White	HBLST302SW	HBLST302W



HBLST302W

Toggle

Color	Catalog No. with Screws	Catalog No. Snap In
Black	HBLTO310SBK	HBLTO310BK
Gray	HBLTO310SGY	HBLTO310GY
Elec. Ivory	HBLTO310SI	HBLTO310I
White	HBLTO310SW	HBLTO310W



HBLTO310W

Blank

Color	Catalog No. with Screws	Catalog No. Snap In
Black	HBLBL300SBK	HBLBL300BK
Gray	HBLBL300SGY	HBLBL300GY
Elec. Ivory	HBLBL300SI	HBLBL300I
White	HBLBL300SW	HBLBL300W



HBLBL300W

Furniture Connectivity Boxes



This family of furniture connectivity boxes assimilates into conference tables and individual work stations to bring power, voice, data, and Audio Video connectors directly to the point of use, providing a standard Hubbell aesthetic design and a wire-free look.

Features/Benefits

- Quick and easy installation, access and use.
- Seamless technology and aesthetics.
- Compliments desktop environments.

Specifications

- ◆ Durable powder coated 16 ga. Steel construction.
- ◆ Optional flip-up doors provide easy access to power and data devices.
- ◆ Integrated power and data separation reduces EMI.
- ◆ Field configurable voltage separator (included).
- ◆ Configurable for any combination of power, data, voice and multimedia connectivity.



Furniture Connectivity Box, Square, Flush-Mount



HBLSHA2

Square, Flush Mount Boxes

With cover.

Gang	Finish	Catalog No.
2	Crinkle Black	HBLSHA2
2	Stainless steel	HBLSHA2BSS

Features/Benefits

- Mounts to conference table or work surface.
- Adjustable "hold downs" simplify installation.
- Configurable for power, voice, data and multimedia.
- Flip-up covers conceal box when not in use.

Furniture Connectivity Box, Rectangular, Flush-Mount



HBLPHA2

Rectangular, Flush Mount Boxes

With cover.

Gang	Finish	Catalog No.
2	Crinkle Black	HBLPHA2
4	Crinkle Black	HBLPHA4
2	Stainless steel	HBLPHA2BSS
4	Stainless steel	HBLPHA4BSS

Features/Benefits

- Mounts to conference table or work surface.
- Adjustable "hold downs" simplify installation.
- Configurable for power, voice, data and multimedia.
- Flip-up covers conceal box when not in use.

Furniture Connectivity Box, Surface Mount

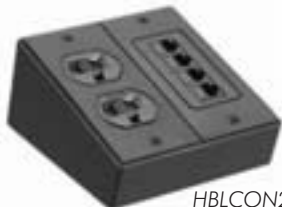

HBLCON2

Surface Mount Boxes

Gang	Finish	Catalog No.
2	Crinkle Black	HBLCON2
4	Crinkle Black	HBLCON4

Features/Benefits

- Low-profile 2- and 3-gang designs.
- The angled profile compliments desktop environments.
- This enclosure provides durability without sacrificing aesthetics.

Furniture Connectivity Box, Recessed Mount

Recessed Mount Boxes

With cover.

Gang	Finish	Catalog No.
2	Crinkle Black	HBLMIR2
4	Crinkle Black	HBLMIR4

Features/Benefits

- Mounts to conference table or work surface.
- Secure under table "screw down" installation.
- Configurable for power, voice, data and multimedia.
- 90° recessed design facilitates cable routing.



HBLMIR4

Furniture Connectivity Box, Under Desk Mount

Under Desk Mount Boxes

Gang	Finish	Catalog No.
2	Crinkle Black	HBLMAR2
3	Crinkle Black	HBLMAR3

Features/Benefits

- Mounts to conference table or work surface.
- Secure under table "screw down" installation.
- Configurable for power, voice, data and multimedia.
- Low-profile.



HBLMAR2

Modular Face Plates

Delivery: 1 face plate with mounting screws.

Description	Catalog No. Black	Catalog No. Gray
iSTATION™	HBLIMFSBK	HBLIMFSGY
Keystone	HBL317SBK	HBL317SGY
Blank	HBLBL300SBK	HBLBL300SGY
Duplex	HBLST302SBK	HBLST302SGY
Single Receptacle Opening (1.39" Diameter)	HBLTL319SBK	HBLTL319SGY
Single Receptacle Opening (1.56" Diameter)	HBLTL318SBK	HBLTL318SGY
Decorator	HBLDE301SBK	HBLDE301SGY
Toggle	HBLTO310SBK	HBLTO310SGY



Face Plates, Rear-Loading



Features/Benefits

- Provides a rear loading, snap in, flush mounting of Hubbell jacks and AV keystone connectors.
- Available in single and double-gang.
- Individual port configurations allow specification flexibility.
- All IFP plates are supplied with paper labels, clear screw covers, and color-matched screw covers.

Specifications

- ◆ UL listed and cUL certified.
- ◆ ANSI/TIA-606-B station labeling.
- ◆ UL 94V-0 rated flame-retardant material.
- ◆ Mounts to standard NEMA openings and boxes.



- Designed to flush mount with box eliminator.
- Durable construction.
- Complemented by a broad range of voice/data/video connectors



IFP Face Plates, Single-Gang



	1-port	2-port	3-port	4-port	6-port
Unit Package	1 per Bag	1 per Bag	1 per Bag	1 per Bag	1 per Bag
Order Qty.	Carton of 25	Carton of 25	Carton of 25	Carton of 25	Carton of 25
Color	Catalog No.	Catalog No.	Catalog No.	Catalog No.	Catalog No.
See Color Code	IFP11XX ✓10G	IFP12XX ✓10G	IFP13XX ✓10G	IFP14XX ✓10G	IFP16XX ✓10G

IFP Face Plates, Double Gang

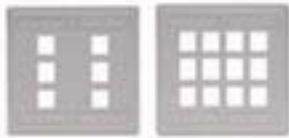

	6-port	9-port	12-port
Unit Package	1 per Bag	1 per Bag	1 per Bag
Order Qty.	Carton of 10	Carton of 10	Carton of 10
Color	Catalog No.	Catalog No.	Catalog No.
See Color Code	IFP26XX ✓10G	IFP29XX	IFP212XX

Multimedia Wall Plates



Accepts AV and Voice/Data connectors. High impact resistant thermoplastic plate. UL Listed 1863 - Communication Circuit Accessory and CSA Certified. See the Residential Section, page XX for more information.

Standard 1-Gang, 4.625" x 2.875" ✓10G

Ports	1-port	2-port	3-port	4-port	6-port
See Color Code	NSP11XX	NSP12XX	NSP13XX	NSP14XX	NSP16XX

Standard 2-Gang, 4.625" x 2.875" ✓10G

Ports	4-port	6-port
See Color Code	NSP24XX	NSP26XX

Midsize 1-Gang, 4.875" x 3.125" ✓10G

Ports	1-port	2-port	3-port	4-port	6-port
See Color Code	NSP101XX	NSP102XX	NSP103XX	NSP104XX	NSP106XX

Blank Wall Plates



Standard, Nylon

Ports	1-Gang	2-Gang	3-Gang	4-Gang
See Color Code	NP13XX	NP23XX	NP33XX	NP43XX

Mid-Size, Nylon

Ports	1-Gang	2-Gang
See Color Code	NPJ13XX	NPJ23XX

Angled Face Plates, 4-port



Color	Gray	Office White	Telco Ivory	White
Catalog No.	AFP14G ✓10G	AFP14 ✓10G	AFP14I ✓10G	AFP14W ✓10G

XX = Plate Color Options

AL=Almond	BK=Black	EI=Electric Ivory	GY=Gray	LA=Light Almond	OW=Office White	W=White
-----------	----------	-------------------	---------	-----------------	-----------------	---------



Stainless Steel Plates



- Designed to fit iSTATION™ modules and AV connectors.
- Ease of use: front and rear-loading capabilities.
- Easy AV application configuring.

Stainless Steel Faceplates - SSF, are designed for flush mount applications, accepting Hubbell's extensive line of jacks and AV connectors that snap mount flush into the keystone opening, creating an elegant stream-line look.

Features/Benefits

- Designed to accept UTP, Coax, and Fiber keystone connectors.
- Rear flush-mounting improves tamper resistance.

Specifications

- ◆ Type 430 stainless steel.
- ◆ Brushed stainless steel finish.



Hlabel HUBBELL Compatible with Hubbell Labeling System - see page M8.

SSF Stainless Steel Plates

Single-gang

	1-port	2-port	3-port	4-port	6-port
Unit Package	1 per Bag	1 per Bag	1 per Bag	1 per Bag	1 per Bag
Order Qty.	Carton of 25	Carton of 25	Carton of 25	Carton of 25	Carton of 25
Catalog No.	SSF11 <small>10G</small>	SSF12 <small>10G</small>	SSF13 <small>10G</small>	SSF14 <small>10G</small>	SSF16

NOTE: All SSF plates will accept AV keystone connectors and XCELERATOR™ jacks.



SSF11 SSF13 SSF16

Double-gang

	4-port	6-port	9-port	12-port
Unit Package	1 per Bag	1 per Bag	1 per Bag	1 per Bag
Order Qty.	Carton of 10	Carton of 10	Carton of 10	Carton of 10
Catalog No.	SSF204 <small>10G</small>	SSF206 <small>10G</small>	SSF209	SSF212

NOTE: All SSF plates will accept AV keystone connectors and XCELERATOR™ jacks.



SSF206 SSF209

iSTATION™ Plates

Gang	1-Gang	2-Gang	3-Gang	4-Gang
Catalog No.	IMS1	IMS2	IMS3	IMS4



IMS1 IMS2

SSF Stainless Steel Plate with Label Fields

Single-gang	1-port	2-port	3-port	4-port	6-port
Unit Package	1 per Bag	1 per Bag	1 per Bag	1 per Bag	1 per Bag
Order Qty.	Carton of 25	Carton of 25	Carton of 25	Carton of 25	Carton of 25
Catalog No.	SSFL11 <small>10G</small>	SSFL12 <small>10G</small>	SSFL13 <small>10G</small>	SSFL14 <small>10G</small>	SSFL16

NOTE: All SSF plates will accept AV keystone connectors and XCELERATOR™ jacks.



SSFL16 SSFL212

Double-gang	4-port	6-port	9-port	12-port
Unit Package	1 per Bag	1 per Bag	1 per Bag	1 per Bag
Order Qty.	Carton of 25	Carton of 25	Carton of 25	Carton of 25
Catalog No.	SSFL24 <small>10G</small>	SSFL26 <small>10G</small>	SSFL29	SSFL212

NOTE: All SSF plates will accept AV keystone connectors and XCELERATOR™ jacks.

SSF Stainless Steel AV Face Plates

Gang	1-Gang	2-Gang	2-Gang	2-Gang
Ports	4-port	6-port	6-port	10-port
VGA Opening	1	1	2	1
Catalog No.	SSF14V	SSF26V	SSF262V	SSF210V

NOTE: All SSF plates will accept AV keystone connectors and XCELERATOR™ jacks.



SSF26V

Decorator Plates and Frames



Specifications

- ◆ IFP plate material: UL 94V-0 rated flame-retardant, all other plastic plates: high-impact nylon.
- ◆ IFP126OW and IFP18OW are UL listed for power and low voltage data applications.
- ◆ Metal plate material: brushed stainless steel, or solid, brushed brass.
- ◆ ANSI/TIA/EIA-606-A station labeling capability.
- ◆ Mounts to standard NEMA openings and boxes.



- IFP126OW is the Only Decorator Plate in the Industry that is UL Listed for Power and Low-Voltage with Label Fields.
- ISF Decorator Frames fit industry Standard Rectangular (GFCI) Style Openings.
- Tamper-Resistant, Rear Keystone Mounting.
- Nylon Plates Virtually Unbreakable.

Hlabel HUBBELL Compatible with Hubbell Labeling System - see page M8.

Decorator Wall Plates



Standard, Nylon

Ports	1-Gang	2-Gang	3-Gang	4-Gang	5-Gang	6-Gang
See Color Code	NP26XX	NP262XX	NP263XX	NP264XX	NP265XX	NP266XX

Mid-Size, Nylon

Ports	1-Gang	2-Gang	3-Gang	4-Gang
See Color Code	NPJ26XX	NPJ262XX	NPJ263XX	NPJ264XX

Snap On

Ports	1-Gang	2-Gang	3-Gang	4-Gang	5-Gang	6-Gang
See Color Code	RCW1XX	RCW2XX	RCW3XX	RCW4XX	RCW5XX	RCW6XX

Decorator and IFP Cover Plates



HPWB262

IFP126OW

Color/Finish	Decorator Single-Gang	Decorator Double-Gang	IFP Decorator w/Label Fields Single-Gang
Brass	SB26	SB262	-
Office White	-	-	IFP126OW
Stainless Steel	SS26	SS262	-

Decorator Outlet Frames, Unloaded



ISF2OW

ISF3GY

ISF4W

ISF6BK

NS620I

	2-port	3-port	4-port
Unit Package	1 per Bag	1 per Bag	1 per Bag
Order Quantity	Carton of 10	Carton of 10	Carton of 10
See Color Code	ISF2XX ✓10G	ISF3XX ✓10G	ISF4XX ✓10G
Unit Package	6-port	Blank	
Order Quantity	1 per Bag	1 per Bag	
See Color Code	ISF6XX	NS620XX	

XX = Plate/Frame Color Options

AL=Almond	BK=Black	EI=Electric Ivory	GY=Gray	LA=Light Almond	OW=Office White	W=White
-----------	----------	-------------------	---------	-----------------	-----------------	---------



Specialty Plates



- IFP18OW is the only Duplex opening plate in the industry that is UL listed for power and low-voltage with label fields.
- 106 frames fit industry standard duplex style openings.

Features/Benefits

- Instant communication mounting capabilities within a duplex electrical design.
- Frames deliver 2- to 6-port configurations, lending flexibility and increased capacity to the work area.

Specifications

- ◆ High-impact polymer construction.



Duplex and IFP Cover Plates

Color/Finish	Duplex Single-Gang	Duplex Double-Gang	IFP Duplex w/Label Fields Single-Gang
Black	NP8BK	NP82BK	-
Brass	SB8	SB82	-
Electric Ivory	NP8EI	NP82EI	-
Gray	NP8GY	NP82GY	-
Light Almond	NP8LA	NP82LA	-
Office White	-	-	IFP18OW
Stainless Steel	SS8	SS82	-
White	NP8W	NP82W	-



HPWS82



IFP18OW

Duplex Wall Plates

Standard, Nylon	1-Gang	2-Gang	3-Gang	4-Gang
Ports	1-Gang	2-Gang	3-Gang	4-Gang
See Color Code on Page 30	NP8XX	NP82XX	NP83XX	NP84XX



Mid-Size, Nylon	1-Gang	2-Gang
Ports	1-Gang	2-Gang
See Color Code on Page 30	NPJ8XX	NPJ82XX

Duplex 106 Outlet Frames

	2-port	4-port
Black	BR106B ✓10G	Q106B ✓10G
Electric Ivory	BR106E ✓10G	Q106E ✓10G
Gray	BR106G ✓10G	Q106G ✓10G
Office White	BR106C ✓10G	Q106O ✓10G
White	BR106W ✓10G	Q106W ✓10G



BR106B



Q106O

Box Eliminator

Description	Catalog No.
Single-gang box eliminator used in place of an electrical box, inserts into, and secures to a drywall opening providing a means to mount a single-gang plate.	BRBE1
Double-gang box eliminator used in place of an electrical box, inserts into, and secures to a drywall opening providing a means to mount a double-gang plate.	BRBE2

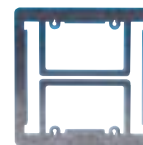

BRBE2

630 Wall Mount Phone Plates

Designed for use with wall mount telephones. Provides corrosion-resistance, durability and will mount to any standard single-gang box. Available in a flat, flush-mount or recess style.

Stainless Steel, Single-gang wall phone plate	Includes	Catalog No.
Jack Format		
Flush	6-position USOC gray jack, RJ25	P630S1GJ6
Flush	8-position Category 5e, gray jack, RJ45	P630S1GJ8
Flush	8-position Category 6, gray jack, RJ45	P630S1GC6
Flush	8-position 10GbE, gray jack, RJ45	P630S1GJ10G ✓10G
Recessed	6-position USOC gray jack, RJ25	P630SR1GJ6
Recessed	8-position Category 5e, gray jack, RJ45	P630SR1GJ8
Recessed	8-position Category 6, gray jack, RJ45	P630SR1GC6
Recessed	8-position 10GbE, gray jack, RJ45	P630SR1GJ10G ✓10G



Secure-IT™ Plates

Staggered, angled openings provide proper cable exit and bend radius.



Port I.D. label fields.

Available in tamper resistant and weatherproof versions, **Secure-IT™** plates protect mated and unmated connections from physical damage. The weatherproof version is rain-tight, providing NEMA 3R protection in outdoor environments.

The unique sliding cover discourages unauthorized personnel from making impromptu and unrecorded moves, adds, and changes. Additional security is assured by fastening an included combo-head screw or user supplied security screw under the top face plate label field (not available in weatherproof version).

HLabel HUBBELL Compatible with **Hubbell Labeling System** - see page M8.

HUBBELL Advantage

- The sliding cover provides better protection and longer life.
- Multiple labeling options for easy station identification.
- Fiber and multimedia capabilities.

Specifications

- ◆ UL 94V-0 rated flame-retardant polymer.
- ◆ Mounts to standard NEMA boxes (16in³ minimum) and common box eliminators.
- ◆ Weatherproof plate is NEMA 3R rated.
- ◆ UL and cUL listed.



Secure-IT™ Face Plates



Tamper-Resistant Face Plates

Size	Color	Face Plate Catalog No.	Replacement Cover Catalog No.	Cable-Thru Plate Catalog No.
1-gang/4-port	Black	TPF1BK	TPFCLBK	TPCP1BK
1-gang/4-port	Gray	TPF1GY	TPFCLGY	TPCP1GY
1-gang/4-port	Office white	TPF1OW	TPFCLOW	TPCP1OW
1-gang/4-port	White	TPF1WH	TPFCLWH	TPCP1WH

Weatherproof Face Plates

Size	Color	Face Plate Catalog No.	Replacement Cover Catalog No.
1-gang/4-port	Gray	TWPF1GY	ERFCLGY

Furniture Plates



Hubbell's furniture plates service the common ANSI/TIA/EIA standard furniture openings. The plates provide keystone flush mounting accommodating HPW's extensive line of multimedia Audio Video connectors.

Specifications

- ◆ Material: high-impact, thermoplastic construction (UL 94V-0).

HUBBELL Advantage

- Work area and individual port identification labeling.
- FP plate positions connectivity outside the furniture channel maximizing internal capacity.

Furniture Plates (Steelcase, Haworth, HON, Knoll, etc.)



Opening size:	2.71" x 1.38"	2.71" x 1.38"	2.71" x 1.38"	2.71" x 1.38"	2.71" x 1.38"
Color	2-port	4-port	4-port Box	4-port T568A	4-port T568B
Black	FP2BK	FP4BK	FP4BBK <small>10G</small>	FM5E4A	FM5E4B
Gray	FP2GY	FP4GY	FP4BGY <small>10G</small>	-	-

Furniture Reducing Adapter (Herman Miller)



The HMRBXX adapter plate may be used with the FP2, FP4, or FM5 series furniture plates only for Herman Miller applications.

Opening size:	2.982" x 1.882"	2.982" x 1.882"
Color	Catalog No. Black	Catalog No. Gray
	HMRBBK	HMRBGY



International Plates

Hubbell's international frames, plates and modules provide angled and flat shuttered configurations compatible with standard international style back boxes and floor boxes. These attractive plates deliver field-configurable mounting for HPW's extensive line of Ascent and XCELERATOR™ series jacks.



EMB1 frame with 2 EM1S modules.



EBM1 frame with 2 EAM1S modules.



UK-style Modules



Shuttered, Unloaded
50 x 25mm
Catalog No.

EM1S ✓10G



Shuttered, Unloaded
37 x 22.5mm (LJ6C)
Catalog No.

EM6S ✓10G



Angled, Shuttered
Unloaded
50 x 25mm
Catalog No.

EAM1S ✓10G



Angled, Shuttered
Unloaded
37 x 22.5mm (LJ6C)
Catalog No.

EAM6S ✓10G



Blanking Plate
50 x 12.5mm
Catalog No.

EMB12



Blanking Plate
50 x 25mm
Catalog No.

EMB25

UK-style Frames



Single-gang, Bevelled
50 x 50mm
Catalog No.

EBM1

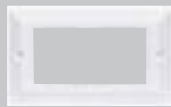

Double-gang, Bevelled
100 x 50mm
Catalog No.

EBM2



Single-gang
50 x 50mm
Catalog No.

EMBP1



Single-gang
100 x 100mm
Catalog No.

EMBP2

UK-style Plates



Single-gang, 1-port
Plate, Unloaded
Catalog No.

BPS11 ✓10G

Flat

Beveled



Single-gang, 2-port
Plate, Unloaded
Catalog No.

BPS12 ✓10G

BPS12A ✓10G

French-style Modules



Single Module, Unloaded
45 x 45mm
Catalog No.

EM41S ✓10G



Dual Module, Unloaded
45 x 45mm
Catalog No.

EM42S ✓10G



Angled, Dual Module, Unloaded
45 x 45mm
Catalog No.

EM42SA ✓10G

Surface Mount Boxes



Integrated fiber storage posts facilitate the storage of 1m of fiber cable (4, 6, 12-port).

- Contains fiber storage posts.
- Accepts Hubbell **UTP** jacks and AV keystone connectors.
- The ISM has the ability to mount to multiple surfaces like standard electrical boxes, non-metallic raceway, the **RE-BOX®**, CP enclosure, rack rail, desktops, walls, and modular furniture.

Features/Benefits

- Low-profile design.
- Available in 5 color options.
- ADA compliant.
- 4-, 6- and 12-port surface box covers feature easy to remove knockouts to accommodate Hubbell raceway.
- 4- and 6-port: all ports are on one side, can be mounted horizontally or vertically so cords may exit sideways or downward.

Specifications

- ◆ Provided with double-sided tape and mounting screws for easy installation.
- ◆ UL and cUL listed.
- ◆ Constructed with a high impact resistant, flame-retardant polymer.
- ◆ TIA/EIA-606B compliant.
- ◆ Bases include tie-wrap anchors at side and rear cable entry points for 4" cable ties (included).

Hlabel HUBBELL Compatible with **Hubbell Labeling System** - see page M8.

POLYTRAK® Raceway Compatibility Chart

Series	PT2	PP	PL	PW	PB	PS
ISM1		▲			▲*	
ISM2		▲			▲*	
ISM4		▲	▲	▲	▲*	
ISM6		▲	▲	▲	▲*	
ISM12		▲	▲	▲	▲*	

* Use #PB3REDA transition fitting.

ISM Surface Mount Boxes, 12-port



Ideal for open office MUTOA cabling, large capacity surface mount applications and retrofits to support data, voice, and multimedia installations. Can be mounted with supplied surface mounting screws or double-sided adhesive tape and mounted to NEMA electric boxes or relay racks (see **POLYTRAK®** raceway compatibility chart).

Size 12-port
 Catalog No.
 See chart **ISM12XX**



ISM Surface Mount Boxes, 4- and 6-port



Ideal for open office MUTOA cabling, compact surface mount environments, and retrofits to support data, voice, and multimedia applications. Features adjustable furniture latches to provide an additional mounting option to common ANSI/TIA/EIA standard furniture openings, and solutions requiring fiber. Box bases feature fiber storage posts that can store 1 meter fiber cable after termination.

	4-port, Stencilled (ID Port 1,2,3,4) Office White	6-port
Size	Catalog No.	Catalog No.
See chart	ISM4XX ✓10G	ISM4OWID ✓10G ISM6XX ✓10G



ISM Surface Mount Boxes, 1- and 2-port



Ideal for open office, compact surface mount environments, and retrofits to support data, voice, and multimedia applications. Can be mounted with supplied surface mounting screws or double-sided adhesive tape.

	1-port	2-port
Size	Catalog No.	Catalog No.
See chart	ISM1XX ✓10G	ISM2XX ✓10G



XX = Surface Mount Box Color Options

BK=Black	EI=Electric Ivory	GY=Gray	OW=Office White	W=White
----------	-------------------	---------	-----------------	---------



OFPPL Multimedia Plate

The OFPPL multimedia housing accommodates 3 SC duplex or 6 ST-style or 3 LC Quad adapters. In addition, there are 4 keystone openings for Jacks or A/V connectors.

Features/Benefits

- Work area label field.
- Fiber drum storage.
- Accommodates 4 Keystone connectors.

Specifications

- ◆ High-impact housing: UL 94V-0 rated.



OFPPL

OFPBST2

OFPPL

Description	Catalog No.
Office white housing, cover and mounting accessories	OFPPL
OFP Bracket with 2 ST couplers SM/MM	OFPBST2

NOTE: SC duplex and LC Quad connectors mount directly to the OFPPL base.

Hlabel HUBBELL Compatible with Hubbell Labeling System - see page M8.

AMO - Advanced Multimedia Outlet Housing

The Advanced Multimedia Outlet (AMO) is a high-capacity, low-profile, multimedia surface housing capable of supporting up to 12 copper/fiber connectors or 24 small form factor LC connectors.

The AMO may be used as a multi-user telecommunications outlet assembly (MUTOA) as specified in TIA-568-C standard

Features/Benefits

- Excellent as a MUTOA.
- Downward orientation.
- Hidden label field beneath cover.
- Compatible with **POLYTRAK®** (PT2, PL and PW).

Specifications

- ◆ High-impact housing: UL 94V-0 rated.
- ◆ AMO dimensions:
7.15"W (181) x 7.53"H (191) x 2.3"D (58).



AMO (loaded)

AMO is our largest capacity surface mount housing accommodating 12 copper or 12/24 fiber connections.



AMO Base Unit Housing and Adapter Brackets



AMO Housing

Description	Catalog No.
Office white housing with 6 bracket locations	AMO

Adapter Brackets

Description - Color: Office White	Catalog No.
SC Adapter - includes 1 duplex Phosphor Bronze SC adapter	AMOBSCD
ST-style Adapter - includes 2 Phosphor Bronze ST-style adapters	AMOBST2
LC Quad Adapter - includes LC Quad adapter	AMOLCQ
Blank Adapter - Sold in packs of 10	AMOBL10
Single Jack Adapter - Sold in packs of 10	AMOBJ10
Dual Jack Adapter - Sold in packs of 10	AMOB2J10
BNC Adapter - 1/2" opening - Sold in packs of 10	AMOBBN10
F-style Adapter - 3/8" opening - Sold in packs of 10	AMOFB10
RCA Solder-type Adapter - 1/4" opening - Sold in packs of 10	AMOBRC10

See page B8 to B12 for more Audio Video connector and bulk connector options.

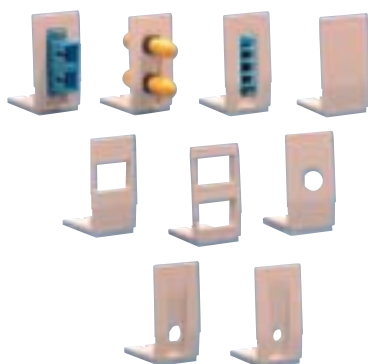

Hlabel HUBBELL Compatible with Hubbell Labeling System - see page M8.

Modular Adapters

Modular 851 Y Adapters



Use to provide solutions for splitting and bridging within modular connectivity channels.

Features/Benefits

- Narrow profile designed to accommodate side-by-side positioning in high-density panel applications.
- Adapter's PCB design provides superior performance in applications requiring splitting or bridging of conductors.

Splitting Y Adapters

Designed for connecting two pieces of voice, data or ancillary equipment to a USOC, RJ61 8-position jack.

Catalog No. **BR851241U**



Converts a T568B wired RJ45 Jack into two 2-pair jacks. Designed for connecting two pieces of voice, data or ancillary equipment.

Catalog No. **BR851241A**



Converts a T568B wired RJ45 jack by splitting pairs 1, 2, and 3 to first 6-positions of jack (1), and pair 4 to positions 4 and 5 of jack (2).

Catalog No. **BR851341B**



Converts a T568B wired RJ45 jack to 2 10/100BASE-T wired RJ45 jacks. Pairs 2 and 3 are split to jack (1), and pairs 1 and 4 are split to jack (2).

Catalog No. **BR851D**



Converts a T568B wired RJ45 jack to a voice wired application (pairs 1 and 4) jack (1), and a 10/100BASE-T application (pairs 2 and 3) wired 8-position jack (2).

Catalog No. **BR851A**



Bridging Y Adapters

Provides a station solution and an option for a speaker, power failure ringer or an ancillary device requiring the use of pair 1.

Catalog No. **BR851441**



Provides 2 RJ45 4-pair jacks in a parallel wiring formation, providing 2 access points to the circuit, adding a common station or in a daisy chain application.

Catalog No. **BR851B**



Modular Adapters

Modular Inline Adapters

Use to provide the ability to connect two HPW patch cords or plug style devices with a straight through wiring format (pin 1 to pin 1, etc.).

Features/Benefits

- Furnished with an adhesive mounting pad for securing to multiple surfaces.
- High-impact thermoplastic.

Position	Dimensions	Color	Description	Catalog No.
8	1.24" x 0.63" x 0.53"	Gray	Non-flanged	BRIA4P
6	1.04" x 0.55" x 0.53"	Black	Non-flanged	BRIA3P
4	1.04" x 0.55" x 0.53"	Telco Ivory	Non-flanged	BRIA2P



Narrow 950 Converter

The 950AI modular adapter converts T568B to T568A wiring format or vice versa, by swapping pairs 2 and 3. This configuration can also be used for crossover communications between two 10BASE-T DTE devices.

Features/Benefits

- Side-by-side stacking.
- High-density design.
- Printed circuit board technology ensures reliability and superior performance.
- High-impact thermoplastic.

Catalog No. **950AI**



Modular 66 Block Adapter

The BR866JC modular 66 adapter provides a modular connection between a 66M block and an RJ45 modular patch cord, by connecting 8 consecutive block positions to a T568B RJ45 jack. See page E20 for additional modular 66 block products.

Features/Benefits

- Stackable design allows access to 48 of the 50 positions on the block.
- Printed circuit board assures superior performance and reliability.
- Allows modular patching on a 66 block - plug-in and network capabilities, cost and labor savings.

Catalog No. **BR866JC**

